

TYPICAL ELEVATION WITH FASTENER SPACING

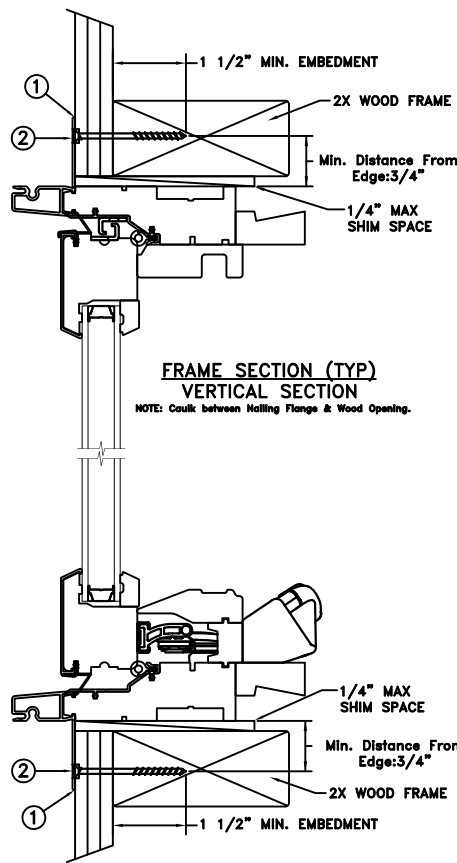

FRAME SECTION (TYP)
VERTICAL SECTION

NOTE: Caulk between Nailing Flange & Wood Opening.

NAIL FIN INSTALLATION

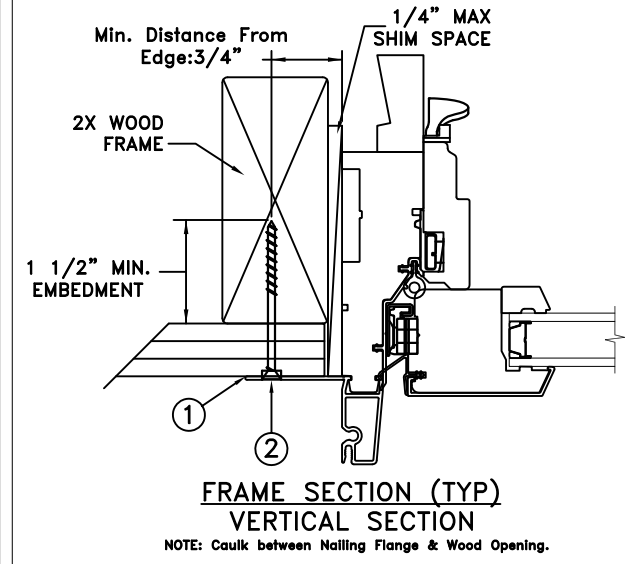

FRAME SECTION (TYP)
VERTICAL SECTION

NOTE: Caulk between Nailing Flange & Wood Opening.

Max Frame	DP	IMPACT
48 X 48	+/-70	NO

Installed Fastener Schedule:

1. Seal flange/frame to substrate.
2. Use #8 PH or greater fasteners through nail fin with sufficient length to penetrate a minimum of 1 1/2" into the wood framing. For 2X wood frame substrate (min. S.G. = 0.42).
3. Host structure (wood buck, stud framing and opening) to be designed and anchored to properly transfer all loads to the structure. The host structure is the responsibility of the architect or engineer of record for the project of installation.

This schedule addresses only the fasteners required to anchor the window to achieve the rated design pressure up to the size limitations noted. It is not intended as a guide to the installation process and does not address the sealing consideration that may arise in different wall conditions. For the complete installation procedure, see the instructions packaged with the window or go to www.jeld-wen.com/resources/installation.

DISCLAIMER:

This drawing and its contents are confidential and are not to be reproduced or copied in whole or in part or used or disclosed to others except as authorized by JELD-WEN Inc.

General Notes:

1. The product shown herein is designed, tested and manufactured to comply with the wind load criteria of the adopted International Building Code (IBC), the International Residential Code (IRC), the Florida Building Code (FBC) and the industry standard requirement for the stated conditions.
2. Buck, framing and masonry by others and is responsibility of architect or engineer of record.
3. All glazing shall conform to ASTM E1300.
4. At minimum, glazing shall be double strength annealed insulating glass.
5. Maximum sizes are buck sizes and do not include fin or flange.

PROJECT ENGINEER: K. Campbell	DATE: 01/21/2015	JELD-WEN 3737 LAKEPORT BLVD. KLAMATH FALLS OR, 97601 PHONE: (541) 882-3451	
DRAWN BY: D. Vezo	SCALE: NTS		
CHECKED BY: K. Campbell	TITLE:	Siteline Clad Awning Window Nail Fin Installation (48" x 48")	
APPROVED BY: D. Stokes			
PART/PROJECT No.:			
IDENTIFIER No. --	PLANT NAME AND LOCATION: Rantoul, IL	CAD DWG. No.:	REV: 00 SHEET 1 of 1.